

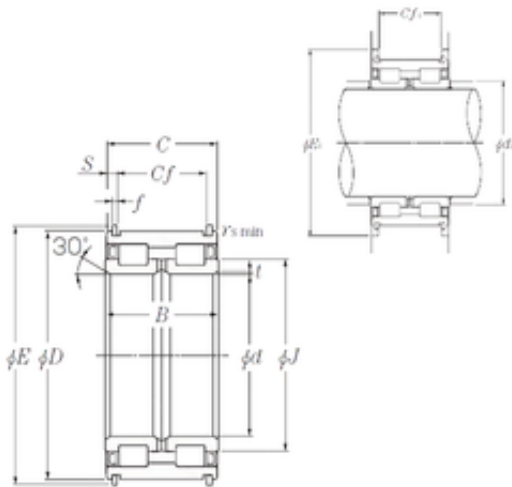

NTN DRIVESHAFT,INC.

380 mm x 560 mm x 243 mm NTN SL04-5076NR SL Type Cylindrical Roller Bearings for Sheaves

Bearing No. SL04-5076NR



SL04-5076NR Bearing 2D drawings and 3D CAD models

Size	380x560x243 mm
Bore Diameter	380 mm
Outer Diameter	560 mm
Width	243 mm
d	380 mm
D	560 mm
B	243 mm
C	241 mm
E1	620 mm
t	3,5 mm
f	10 mm
r min.	2 mm
E	585 mm
J	442 mm
S	23,5 mm
da	392 mm
Cf	194 mm
Cf1	194 mm
Weight	212 Kg
Basic dynamic load rating (C)	3 800 kN
Basic static load rating (C0)	8 750 kN